

**IHI**

Realize your dreams

*IHI contributes to customers by its unique technologies*

# PRECISION CALENDERS for Tire industry

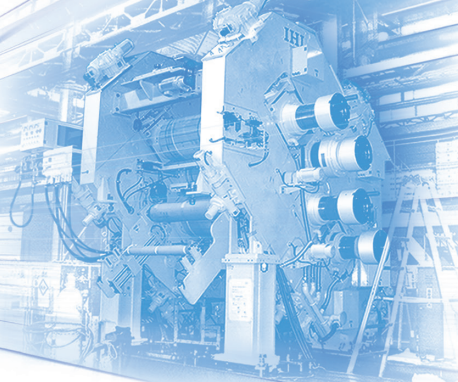
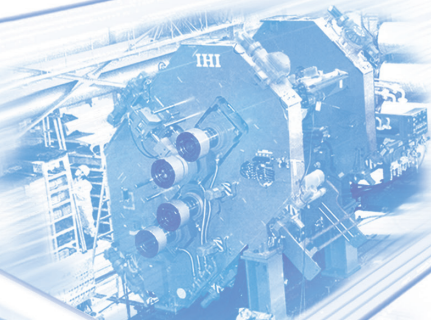

IHI Logistics & Machinery Corporation

# IHI Precision Calenders

*IHI has been delivering high precision Calender lines, which contributes to customers' satisfaction for more than 60 years.*

**Features;**

## High Precision and High Quality based on advanced control systems.

**What we provides**

*IHI provides not only calender itself but also pre-warming equipment (Pork chop extruder & Mixing mills), advanced control systems, turn-key service, etc. in order to boost customers' business development.*

Calender line up

IHI supplies various calender lines according to customers' requirement

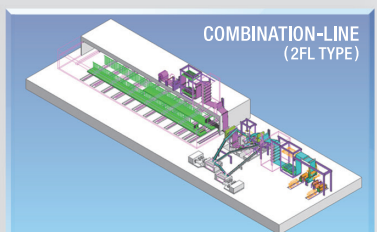
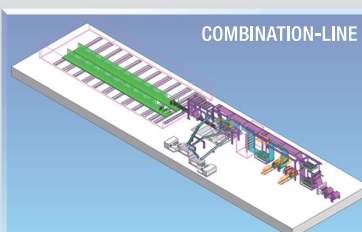
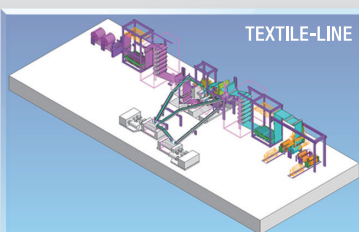
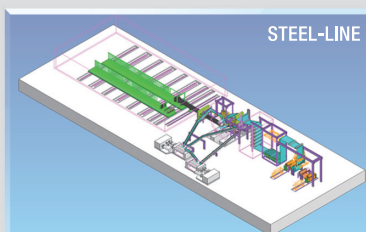

## Unique technologies

### Innovative control system and automation system combined with calendaring process

#### Constant Roll Gap

**Advantage:**  
**improve sheet profile**

- Technology to minimize the influence of frame stretch
- Load fluctuation causes calender frame stretch, and it makes difficult to control sheet profile accurately.
- Keep the distance between bearing boxes constantly

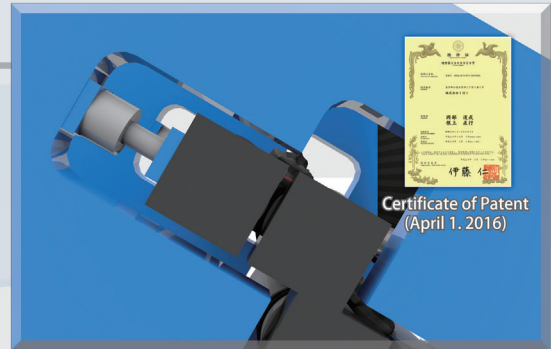

#### Automatic Feeding Control

**Advantage:**  
**improve sheet quality**

- Automatic control system to maintain bank status stably
- Sensing bank status with ultrasonic sensors
- Control system adjusts knives position and conveyor position

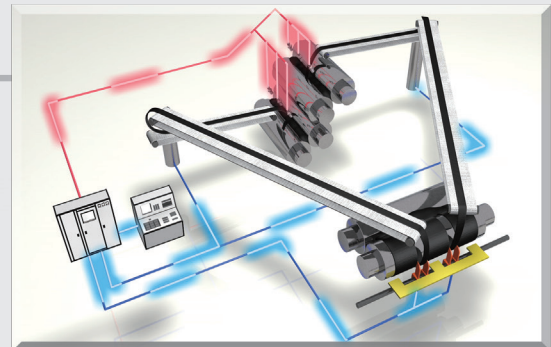

#### Automatic Bobbin Loading

**Advantage:**  
**minimize man-power & labor cost**

- Automatic handling system for bobbin loading in creel room

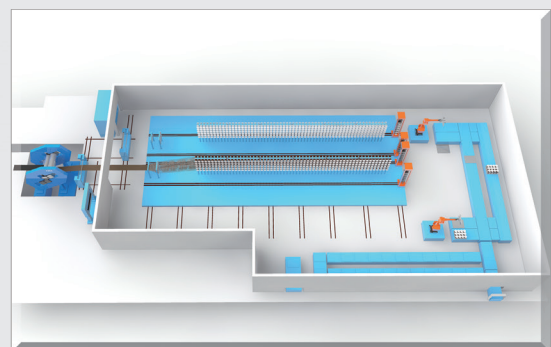
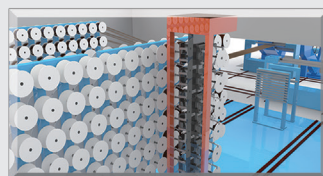

## Unique technologies

### CRG : Constant Roll Gap

#### What is CRG

"Constant Roll Gap" is a feedback control system for improving sheet thickness

#### Function

It cancels the value of calender frame stretch and minimize the influence on sheet thickness control

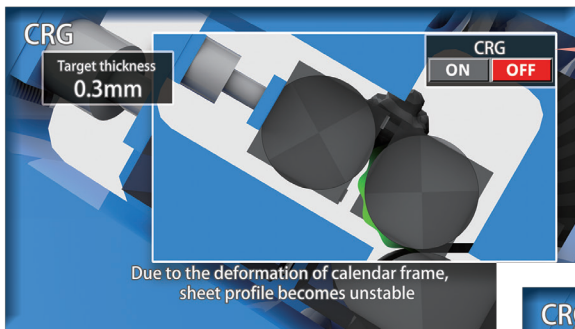
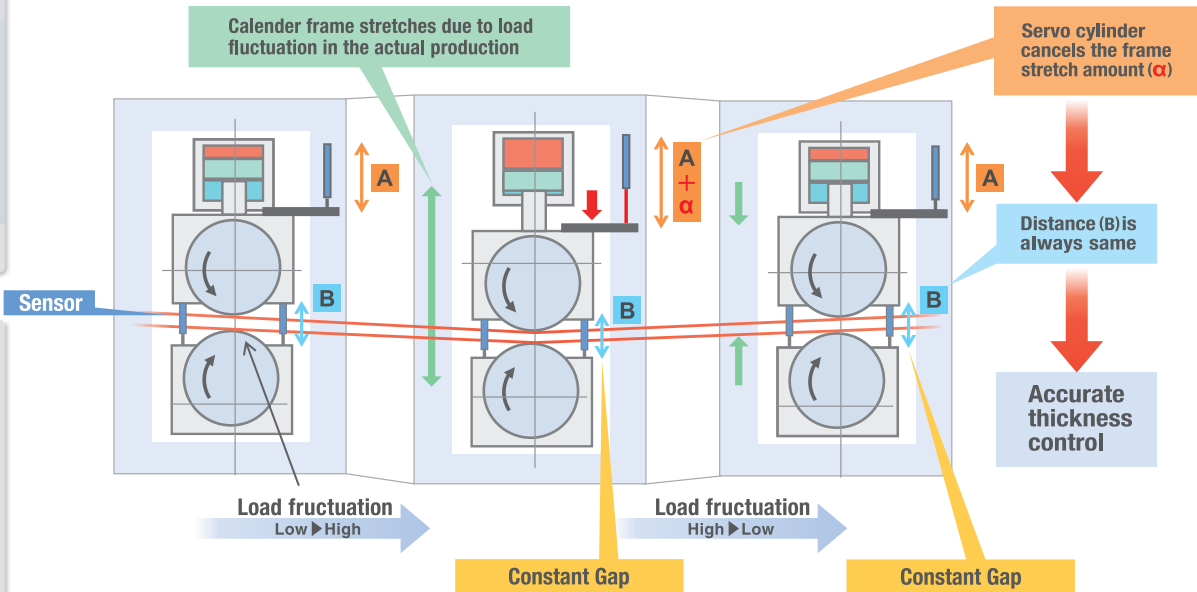

Sheet thickness is unstable due to frame stretch

Minimize the fluctuation of sheet thickness

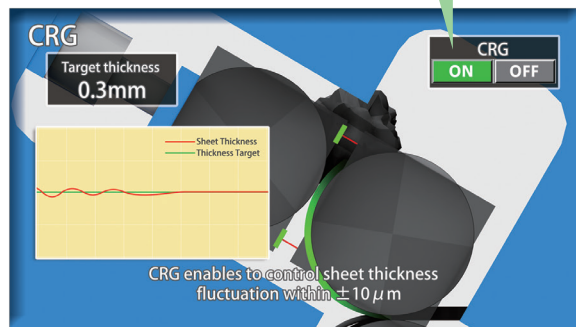

Sheet profile improvement  
Material saving

Advantage

## Unique technologies

### AFC : Automatic Feeding Control

Continuously detecting bank status and control mill knife & conveyor

Realize stable bank status automatically

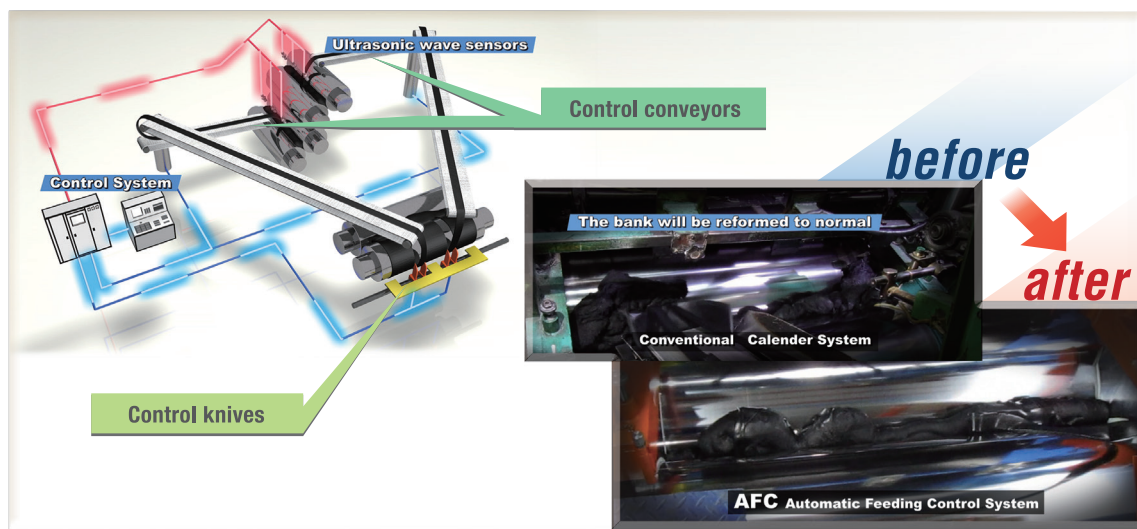

Advantage

Sheet quality improvement

### ABL : Automatic Bobbin Loading

#### Current Problem

Bobbin setting in creel room is unfavorable work from safety and physical workload points of view

#### Solution

Cassette/Robot sets the bobbins to creel stand automatically

#### Cassette Type

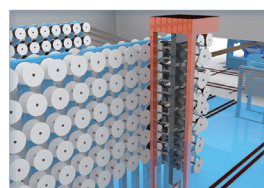
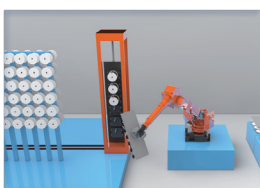
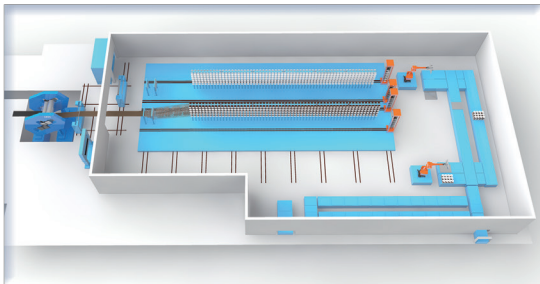

#### Robot Type

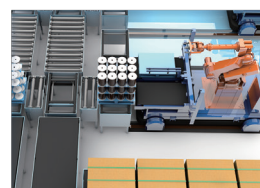
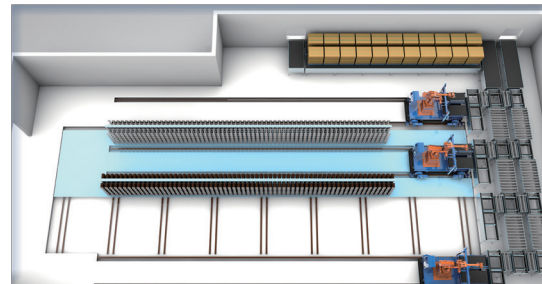

Advantage

Minimize physical workload  
Minimize labor cost

## OUR OFFICES AROUND THE WORLD

### EUROPE, MIDDLE EAST, AFRICA

- LONDON:** IHI Europe Ltd.  
2nd Floor, America House, 2 America Square, London EC3N 2LU, U.K.  
TEL: +44(20)7481-8180 FAX: +44(20)7481-4955
- PARIS:** 17, Rue d'Orleans, 92200 Neuilly sur Seine, FRANCE  
TEL: +33(1)4643-1493 FAX: +33(1)4637-7869
- ALGIERS:** Boulevard du 11 Decembre 1960, Lot No.12 Cooperative Essalam, Appartement No.02, 1er etage, El Biar, Alger, Algeria  
(Mailing Address) BP102.El Biar, Algiers, ALGERIE  
TEL: +213(21)924399 FAX: + 213(21)921436
- MOSCOW:** Office E02-312, 2nd floor, 8, 4th Dobryninskiy Pereulok, Moscow 119049 RUSSIA  
TEL: +7(495)989-6001 FAX: +7(495)989-6005
- ISTANBUL:** Esentepe Mahallesi Harman Sokak, Harmanci Giz Plaza No:5 Kat:18 D:35 34394 Levent-Sisli Istanbul TURKEY  
TEL: +90(850)252-2122 FAX: +90(212)282-8370
- DUBAI:** Burj Daman Building, Level6, Office C609 DIFC, P.O.Box 506940, Dubai, UAE  
TEL: +971(0)4-458-3864 FAX: +971(0)4-458-4096

### ASIA, PACIFIC

- NEW DELHI:** 302A, Salcon Ras Vilas, District Centre Saket, New Delhi-110017, INDIA  
TEL: +91(11)4105-2694 /+91(11)4166-3504 FAX: +91(11)4166-3503
- YANGON:** IHI ASIA PACIFIC PTE. LTD. Yangon Branch  
Unit 309, 3rd Floor, Prime Hill Business Square, No.60, Shwe Dagon Pagoda Road, Dagon Township, Yangon, MYANMAR  
TEL / FAX: +95(1)395526
- BANGKOK:** IHI ASIA PACIFIC (Thailand) CO.,LTD.  
11th Floor,Ramaland Bldg., 952 Rama IV Road, Suriyawongse, Bangrak, Bangkok 10500, Thailand  
TEL: +66(2)236-3490,9099 FAX: +66(2)236-7340
- KUALA LUMPUR:** Letter Box No.52, 19th Floor, UBN Tower, No.10, Jalan P. Ramlee, 50250 Kuala Lumpur, MALAYSIA  
TEL: +60(3)2072-1255 FAX: +60(3)2072-1418
- SINGAPORE:** IHI ASIA PACIFIC PTE. LTD.  
77 Robinson Road, #14-03 Robinson 77, SINGAPORE, 068896  
TEL: +65(6515)6609 FAX: +65(6438)8006
- HANOI:** Unit 515, Sun Red River, 23 Phan Chu Trinh Street, Hoan Kiem District, Hanoi, VIETNAM  
TEL: +84(4)3934-5305 FAX: +84(4)3934-5303
- JAKARTA:** Mid Plaza II, 17th Floor, Jl. Jendral Sudirman Kav.10-11 Jakarta 10220 INDONESIA  
TEL: +62(21)570-7701 FAX: +62(21)570-7705
- SHANGHAI:** IHI (Shanghai) Management Co., Ltd.  
Room 021 24th Floor, Hang Seng Bank Tower,1000, Lujiazui Ring Road, Pudong New Area, Shanghai, 200120 CHINA  
TEL: +86(21)6841-1717 FAX: +86(21)6841-1919
- BEIJING:** IHI (Shanghai) Management Co., Ltd. Beijing Branch  
Room 8008, Chang Fu Gong Office Building No.26, Jian Guo Men Wai Avenue Beijing, 100022 CHINA  
TEL: +86(10)6527-2700 FAX: +86(10)6527-3100
- TAIPEI:** IHI Taiwan Corporation  
Room 1202, Chia Hsin Building., No.96 Section2, Chung Shan North Road, Taipei, 10449 TAIWAN  
TEL: +886(2)2542-5520 FAX: +886(2)2542-4362
- HONG KONG:** IHI (HK) Ltd.  
Room 2203, 22/F, Causeway Bay Plaza 2, 463-483 Lockhart Road Causeway Bay, Hong Kong  
TEL: +852(2522)4093 FAX: +852(2845)2497
- SEOUL:** 23F, Seoul Finance Center B/D, 136, Sejong-Daero, Jung-Gu, Seoul 04520, KOREA  
TEL: +82(2)753-8605 FAX: +82(2)755-4772
- SYDNEY:** IHI ENGINEERING AUSTRALIA PTY. LTD.  
Suite 2201,Level 22,111 Pacific Highway,North Sydney NSW 2060 Australia  
TEL: +61(2)9923-9300 FAX: +61(2)9923-9333

### AMERICAS

- NEWYORK:** IHI INC.  
150 East 52nd Street, 24th Floor, New York, NY 10022, U.S.A.  
TEL: +1(212)599-8100 FAX: +1(212)599-8111
- SÃO PAULO:** IHI do Brasil Representações Ltda.  
Av. Paulista 726, 9 Andar CJ 901-Bela Vista-São Paulo-SP CEP: 01310-910, Brasil  
TEL: +55(11)3521-2593

## IHI Logistics & Machinery Corporation

### Sales Div. Industrial Machinery Sales Dept.

Toyosu IHI Building, 1-1, Toyosu 3-chome, Koto-ku, Tokyo 135-0061, Japan  
TEL +81-3-6204-7327